

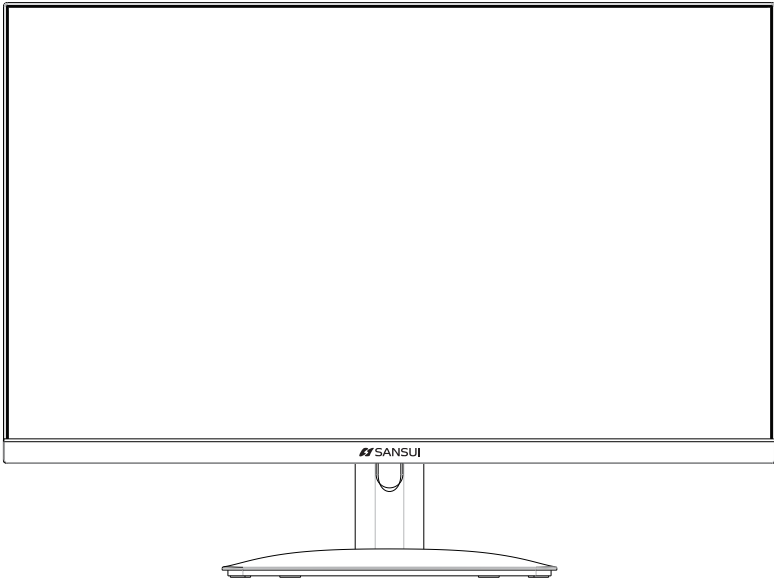

User Manual



Full HD Monitor

ES-24X5A

Before using this machine, please read the manual carefully and keep it for future reference. Color and appearance may vary depending on the specific model of the product. Specifications are subject to future changes to improve performance without notice.

Table Of Contents

Warning! Important Safety Instructions.....	1
Accessories.....	3
Installation of the base.....	3
Adjust The Angle.....	3
Cable connection.....	4
Panel control.....	4
Using The OSD Menu.....	5
Other.....	7
Help.....	7
License.....	7

Warning! Important Safety Instructions

Please read the below warnings carefully before you install and use our product.



RISK OF ELECTRIC SHOCK DO NOT OPEN

CAUTION: DO NOT REMOVE COVER TO REDUCE RISK OF ELECTRIC SHOCK.

There are no user serviceable parts inside. Be sure to have repairs performed by qualified service personnel.

 This symbol means that dangerously high voltage is present inside. Any form of contact with any part inside the product is dangerous.

 This symbol reminds you of the important instructions that come with the operation and maintenance of this product.

- *Slots and holes in the chassis and at the rear and bottom are designed to provide necessary ventilation. Do not block or cover these slots and holes in order to ensure the operability of this machine and to prevent it from overheating.
Do not cover slots and holes with cloth or other materials.
Do not place the machine on beds, sofas, carpets or other similar surfaces to avoid clogging of said slots and holes.
Do not place this machine in restricted spaces (eg bookcases or built-in cupboards) unless proper ventilation is provided. A gap of 10 cm should be maintained between the product and the wall.
- * Do not place this machine near or over electric heaters or radiators, or in places exposed to direct sunlight.
- * Do not place heat-generating objects (such as candles, ashtrays, incense, flammable gas or explosive substances, etc.) near the product.
- * Do not place containers filled with water on this machine as this may result in a fire or electric shock hazard.
- * Do not expose the product to oily substances or chemical agents, as this may cause corrosion of the product casing.
- * Do not expose this machine to rain or near water (e.g. near a bathtub, sink, kitchen sink, or laundry sink, in a wet basement, or near a swimming pool).
If the machine gets wet accidentally, please unplug the power cord or power adapter immediately, and then promptly contact an authorized dealer for further assistance. When cleaning the monitor, be sure to use a dry, soft cloth that does not contain volatile substances. Before cleaning, be sure to unplug the power cord or power adapter.
- * Do not overload wall outlets, extension cords, or integral convenience receptacles as this may result in fire or electric shock.
- * The power cord or power adapter should be placed in a location where it will not be stepped on or squeezed by objects above or next to it, and special attention should be paid to the wires at the plug, at the integral convenience receptacles and at the outlet of the machine.
- * To better protect this machine in lightning weather or when it is left unattended or unused for a long time, please unplug its power cord or power adapter, and disconnect the antenna or cable system.
This prevents damage to the machine during a lightning storm or in the event of a power surge on the power line.
- * Before connecting the AC power cord to the power adapter or monitor power interface (subject to the actual product style), please make sure that your local power supply meets the requirements of power adapter or monitor input voltage.
- * Be sure not to insert any metal objects into the holes of this machine, otherwise it may cause a danger of electric shock.
- * Do not touch the inside of this machine to prevent electric shock. Only qualified technicians are allowed to open the cover of this machine.
- * Make sure that the power cord plug or power adapter can be securely inserted into the outlet. When disconnecting the power cord, make sure to firmly grasp the power plug or power adapter and unplug it from the outlet.
- * Do not touch the power cord or power adapter with wet hands.
- * If the machine does not operate normally, especially if it emits any unusual sound or smell, unplug the power outlet immediately and contact an authorized dealer or service center for further assistance.

Warning! Important Safety Instructions

*If you plan to leave the monitor unused for an extended period of time, or if you are going to be away from home (especially if there are children, the elderly, or people with disabilities left alone), be sure to unplug the power plug or power adapter from the outlet.

Accumulated dust may cause sparks and heat from the power cord or power adapter or cause the insulation of the power cord or power adapter to deteriorate, resulting in electric shock, leakage or fire.

*After the monitor is moved from a low temperature place to a warm area, it should be placed for a period of time before powering on, so that the condensation inside the monitor can be fully dissipated and dried.

*The power supply voltage will be marked on the back of the monitor, DC 12V.

*If you plan to install this product in dusty, high or low temperature, high humidity, chemical-containing environments and 24-hour use locations (such as airports or train stations, etc.), be sure to contact an authorized service center for further assistance. Otherwise, the monitor may be severely damaged.

*Be sure to use only properly grounded plugs and sockets. Poor grounding may result in electric shock or equipment damage. (for Class I equipment only)

*To disconnect the power from the device, the power cord or power adapter plug must be unplugged from the machine, so the power cord or adapter plug should be easily accessible.

*Children are prohibited from climbing on this product.

*Keep the accessory parts out of the reach of children.

*Do not install this product in an unstable location, such as a wobbly shelf, sloping floor, or a location subject to external vibration.

*Do not drop the product or subject it to shock. If the product is damaged, please disconnect the power supply and contact the service center in time for further assistance.

IC Statement:

This device complies with Industry Canada licence-exempt RSS standard(s). Operation is subject to the following two conditions: (1) this device may not cause interference, and (2) this device must accept any interference, including interference that may cause undesired operation of the device.

WARNING:

Changes or modifications not expressly approved by the party responsible for compliance could void the user's authority to operate the equipment.

Technical Specifications:

Operating temperature: -10°C ~ 35°C



Federal Communications Commission Declaration of Conformity



This device complies with Part 15 of the FCC Rules. Operation is subject to the following two conditions: (1) this device may not cause harmful interference, and (2) this device must accept any interference received, including interference that may cause undesired operation.

The following local Manufacturer/Importer is responsible for this declaration:

Product:	LED Monitor
Model Number:	ES-24X5A
SKU Number:	ES-24X5A
Name of Responsible Party:	Global Q International Ltd.
Address of Responsible Party:	2700 E Imperial Hwy Lynwood CA 90262

Accessories

- 1. Please check if all items are included in your monitor set, if there are missing items; please contact your dealer in time.
- 2. Item color and shape may vary by model.
- 3. The cables provided may vary depending on the product purchased.

Manual	 User Manual for Monitor	 Warranty Card
Cable	HDMI cable	Applies only to monitors with HDMI ports. Not all models come with an HDMI cable, you can purchase this accessory separately.
Others	Adapter	

Installation of the base

(*The functions of the monitor may vary depending on the model, the actual product shall prevail)

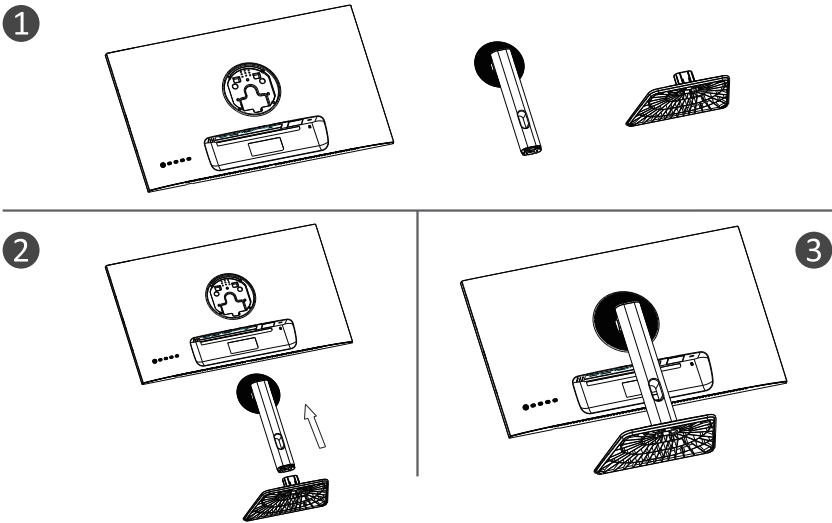

Adjust The Angle

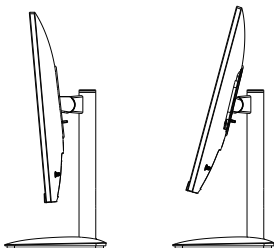





1. Drawings are for reference only and please refer to the actual monitor.
2. The angle of the screen can be adjusted forward 5° backward 15° for a comfortable angle.
3. Be careful not to touch or press the screen area when adjusting the angle of the monitor.

Cable connection

The configuration information on the back of the monitor varies by product model. Read the following contents before connecting the product.

1. Before connecting the product, be sure to check the two ports of the supplied signal cable, as well as the shape and position of the ports on the product and external devices.
2. Before connecting the product, be sure to remove the power cord or power adapter from the product and external devices to prevent damage to the product due to short circuits or overcurrent.
3. After all signal cables are properly connected, connect the power cord or power adapter back to the product and external devices.
4. After completed the connection, be sure to read the manual to familiarize yourself with the product features, precautions, and other information needed to use the product properly.

 <p>HDMI</p>	<p>HDMI: Using a HDMI cable to connect the product's HDMI port to the PC's HDMI OUT port.</p>	 <p>EARPHONE</p>	<p>EARPHONE OUT: Use a headset plug to connect to the EARPHONE OUT jack.</p>
 <p>DP</p>	<p>DP : Please link DP cable of LED to the port named DP IN at the back of the LED Monitor.</p>	<p>DC IN</p>	<p>DC IN 12V: Use the adapter to access the port, the power supply of this interface only supports DC 12V, use the matching adapter to access, please consult the authorized service center for the non-original adapter.</p>
 <p>VGA</p>	<p>PC analog signal input</p>		

Panel control

- ⏻ : Standby/Power Off/On
- ▼ : Down/Game centre
- ▲ : Up /Brightness
- E : Exit/Input Menu
- M : Menu/Select

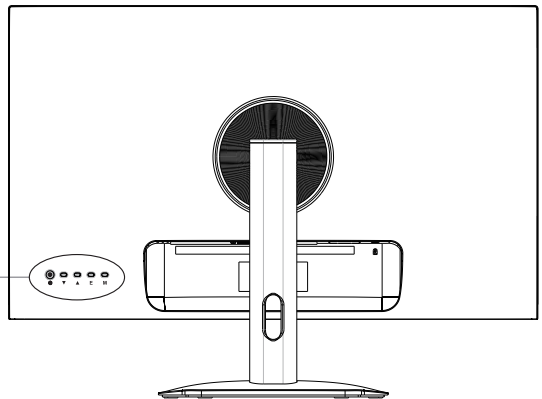
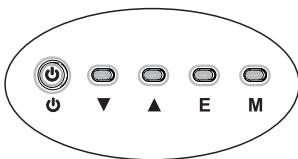

Using The OSD Menu

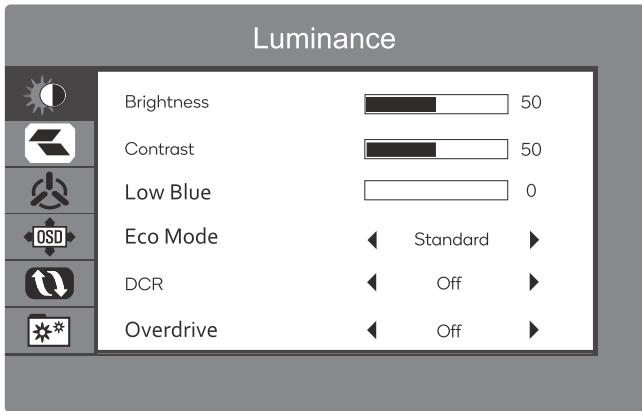

- 1.To view the OSD menu, press the engraving button at the back of the monitor.
- 2.Configuration options press the left/right/up/down keys.
- 3.To return to the previous menu to select a menu item, press the right button.
- 4.To exit the OSD menu, press the right key until you exit.

Main Menu	Sub-Menu	Options	Description
Luminance	Brightness	0~100	Adjust display brightness
	Contrast	0~100	Adjust display contrast
	Low Blue	0~100	Adjust display low Blue
	Eco Mode	Standard, Movie, RTS, FPS, Game, Reading	Set visual mode
	DCR	On, Off	Turn DCR function on/off
	Overdrive	On, Off	Overdrive/On/Off
Image	H. Position	0-100	Adjust the horizontal position
	V.Position	0-100	Adjust the vertical position
	Clock	0-100	Adjust the clock setting
	Phase	0-100	Adjust the clock phase values
	Image Ratio	Wide, 4:3	Set aspect ratio

Using The OSD Menu

Main Menu	Sub-Menu	Options	Description
Color Setup	ColorTemp.	Warm, User, Cool Normal	Adjust color temperature
	Red	0~100	Customize RGB components
	Green	0~100	
	Blue	0~100	
OSD Setup	Language	English Spanish French	Set OSD language
	H.Position	0-100	Adjust the horizontal position
	V.Position	0-100	Adjust the vertical position
	Timeout	0-60	Set how long the OSD remains
	Transparence	0-100	Adjust the OSD transparence value
Reset	Auto config	N/A	Enables this feature to automatically adjust the H/V position, Focus and Clock of picture.
	Auto Color	N/A	Enables this feature to automatically set the color. Restores the default settings.
	Reset	N/A	Reset monitor configurations
Extra	Input Select	VGA , HDMI, DP	Display the input select
	Mute	On/Off	/
	Volume	0-100	Adjust audio volume
	Adaptive-Sync	On, Off	Turn Adaptive-Sync on/off

Other

Plug and Play features:

This monitor can be installed on any compatible Plug and Play system.

The interaction between the monitor and the computer system provides optimal operating conditions and monitor settings.

In most cases, the monitor installation will be automatic unless the user chooses another setting.

Acceptable dead pixels:

The display of this product is made using an advanced semiconductor process with an accuracy of over 1 ppm (parts per million).

But some pixels may be too bright or black when displaying red, green, blue or white, this is not bad quality, please feel relieved to use!

This equipment is Class B IT equipment.

As the angle of the user looking at the screen changes, LED light may be seen on the edge of the product's frame, but this phenomenon is not harmful to the human body and does not affect the product's characteristics and performance.

Help

Black screen appears/Cannot turn on the product

1. Please check if the power adapter is connected correctly
2. Please check whether the power adapter is normally connected to the 100-240V AC socket
3. Please check whether the signal detection cable information is displayed on the screen, check the cable connection between the PC and this product
4. Please check whether the HDMI cable is used for connection, if you connect the HDMI cable after the PC is started, or disconnect and reconnect the HDMI cable while using the PC, the screen may not display an image because some graphics cards cannot output a signal, in this case, please restart the PC after connecting the HDMI cable.

License



The terms HDMI and HDMI High-Definition Multimedia Interface, and the HDMI logo are trademarks or registered trademarks of HDMI Licensing LLC in the United States and other countries.



ENERGY STAR® Qualification.

Enabling certain features and functionality in this product (e.g. Picture Mode, Volume) may increase its energy consumption, possibly beyond the limits required for ENERGY STAR® qualification. This product has earned the ENERGY STAR® qualification meeting US Federal Energy Efficiency guidelines as established by the Department of Energy and Environmental Protection Agency. The ENERGY STAR® program exists to provide energy saving guidelines and help promote energy efficient products and practices.

Power Saving Mode is the mode in which the product qualifies for ENERGY STAR®.